



LUSWAVE

PUPradar--SMART RADAR PLATFORM

# USER MANUAL

© 2020 LUSWAVE TECHNOLOGY, USA  
luswave.com

Luswave Technology LLC

**Sales:** +1-703-338-8380 **Technical:** +1-571-296-6435 **Fax:** +1-571-223-5483 **Email:** [service@luswave.com](mailto:service@luswave.com)

WWW.LUSWAVE.COM

# PUPradar USER MANUAL

© 2020 LUSWAVE TECHNOLOGY, USA  
All Rights Reserved.

## Legal Disclaimer and Important Notice

The information given in this document shall in no event be regarded as a guarantee of conditions or characteristics. With respect to any examples or hints given herein, any typical values stated herein and/or any information regarding the application of the device, Luswave Technology hereby disclaims any and all warranties and liabilities of any kind, including without limitation, warranties of non-infringement of intellectual property rights of any third party. For further information on technology, delivery terms and conditions, please contact Luswave Technology at [www.luswave.com](http://www.luswave.com).

As a low cost device, this single board and small enclosure evaluation kit series is intended for use of engineering development, demonstration, hardware evaluation, algorithm verification, electronic hobby, DIY, and similar purpose only and is not considered to be a finished end-product fit for general consumer use. Persons handling the product(s) must have electronics training and observe good engineering practice standards. As such, the goods being provided are not intended to be complete in terms of required design-, marketing-, and/or manufacturing-related protective considerations, including product safety and environmental measures typically found in end products that incorporate such semiconductor components or circuit boards. This evaluation kit does not fall within the scope of the European Union directives regarding electromagnetic compatibility, restricted substances (RoHS), recycling (WEEE), FCC, CE or UL, and therefore may not meet the technical requirements of these directives or other related directives.

Luswave Technology LLC

**Sales:** +1-703-338-8380 **Technical:** +1-571-296-6435 **Fax:** +1-571-223-5483 **Email:** [service@luswave.com](mailto:service@luswave.com)

[WWW.LUSWAVE.COM](http://WWW.LUSWAVE.COM)

---

# TABLE OF CONTENTS

- 1 Getting Started ..... 4**
  - 1.1 Introduction ..... 4
  - 1.2 Key Features ..... 4
  - 1.3 Kit Contents ..... 5
  
- 2 Hardware Specifications ..... 5**
  - 2.1 Functional Block Diagram ..... 5
  - 2.2 Specifications ..... 5
  - 2.3 Antennas ..... 6
  - 2.4 Data Stream Sequences ..... 7
  
- 3 System Setup ..... 8**
  - 3.1 Mounting Base ..... 8
  - 3.2 USB Driver Setup ..... 8
  - 3.3 PUPradarGUI Setup ..... 10

# 1 Getting started

## 1.1 Introduction

Luswave Technology develops low-power, low-cost, and easy to use radar development platforms, which offer great flexibility for applications in academic research, industrial automation, public safety, and DIY projects.

PUP\_EN24C\_T1R2 is a K-band development platform. This device integrates an RF module and a powerful FPGA-based processor module together. The RF front end consists of one transmitting and two receiving channels, which makes it a Single Output Dual Input (SODI) radar. This device can connect either horn antennas or patch antennas as external antennas. Its FPGA-based micro-controller unit (MCU) and four-channel 50MSPS pipeline LVDS ADC module offers ultimate design flexibility and accuracy with industry-leading programmable logic.

A user-friendly graphical user interface (GUI) allows flexible configuration. Users can easily configure the desired center frequency and bandwidth, waveform modulation mode, sampling rates, display parameters, etc. After signal processing, the waveform, range-Doppler map, and velocity waterfall map are displayed.

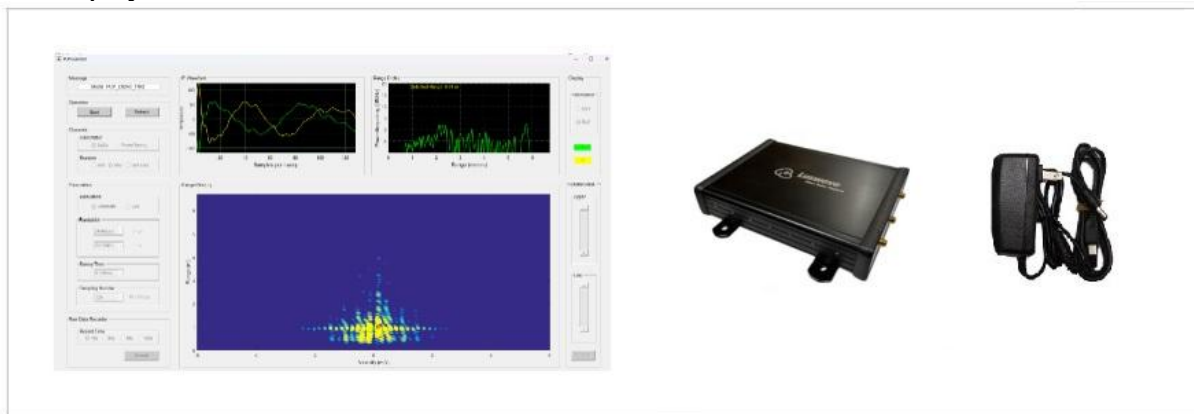

**Figure 1. PUP\_EN24C\_T1R2**

## 1.2 Key Features

- Support for both FMCW and CW modulations
- PLL-controlled waveform creation
- Single Tx channel with power saving mode
- 50MHz four-channel LVDS pipeline AD converters
- Real-time complex (I & Q) data acquisition
- User-friendly graphical user interface (GUI)
- Re-configurable parameters
- Long recording time for raw data
- USB 2.0 high speed (480Mb/s) interface to host computer

Luswave Technology LLC

**Sales:** +1-703-338-8380 **Technical:** +1-571-296-6435 **Fax:** +1-571-223-5483 **Email:** service@luswave.com

### 1.3 Package Contents

The PUP\_EN24C\_T1R2 Development Platform comes with an enclosed radar device and mounting brackets. The development platform includes:

- PUP\_EN24C\_T1R2 Development Platform.
- 6V AC/DC power adapter.
- USB 2.0 A to Mini-B cable.
- A USB flash drive with software and documents.

## 2 Hardware Specifications

### 2.1 Functional Block Diagram

Figure 2 is a block diagram of the PUP\_EN24C\_T1R2 SODI radar development platform. PLL controlled frequency sweep is configured by FPGA-based MCU. Four channel of IF signals are acquired by a 50Mps four-channel single chip LVDS AD converter and then streamed to host computer via a high-speed USB interface (up to 480Mb/s) for further processing. A graphical user interface (PUPradarGUI) is used to control the parameter configuration.

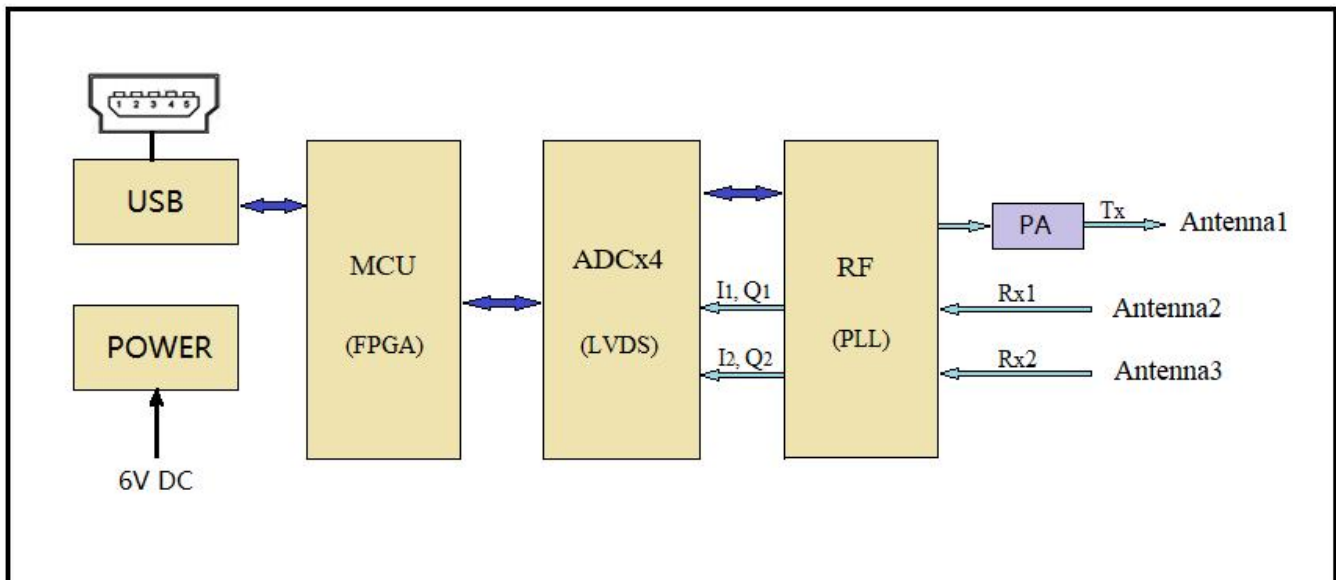

Figure 2. Block Diagram

### 2.2 Specifications

PUP\_EN24C\_T1R2 has one transmitter and two receivers with three SMA connectors for external antennas. Its specifications are shown in Table 1.

**Table 1. Specifications of PUP\_EN24C\_T1R2**

<b>Model</b>	<b>PUP_EN24C_T1R2</b>
Antennas	3 External Antenna Connectors
RF Channels	1 Transmitting, 2 Receiving
Modulations	FMCW, CW
Typical Frequency	24GHz-25GHz (Expandable to 24GHz-26GHz)
Typical Bandwidth	250MHz-1GHz (Expandable to 2GHz)
Tx Output Power	19-21dBm
Rx Noise Figure	10dB
Detectable Range	People: 15-20m, middle sized vehicle: 40-60m
Supply Voltage	6V
Supply Current	1.8A
Operating Temperature	-40°C - 85°C
Dimensions	L: 160mm, W: 125mm, H: 32mm
Weight	16oz-20oz

### 2.3 Antennas

No antenna was included with PUP\_EN24C\_T1R2, RF cables and external antennas should be purchased separately.

Besides general purpose measurements of range, velocity, and direction of arrival etc., antennas can be configured as interferometric radar (Figure 3) using longer RF cables (0.5-1m). Interferometric radar are used to measure micro-vibration of buildings, bridges, machinery, and cargo ship engines, etc.

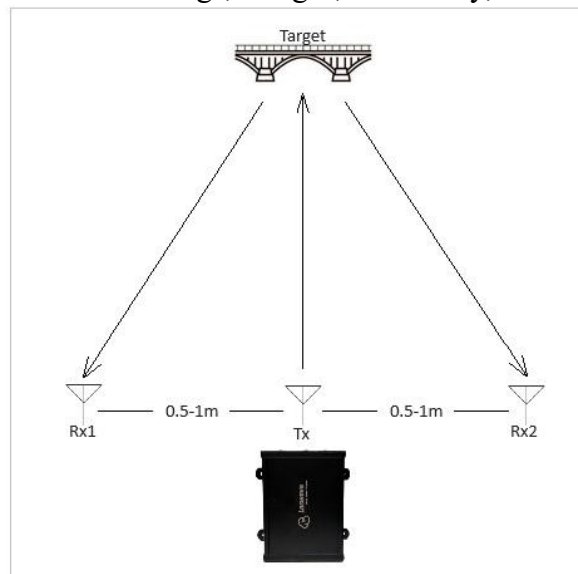

**Figure 3. Interferometric Radar Configuration**

## 2.4 Data Stream Sequences

The receiver channel can be configured as one channel, or two channels. When transmitter is activated, the data stream sequences are illustrated in Figure 4.

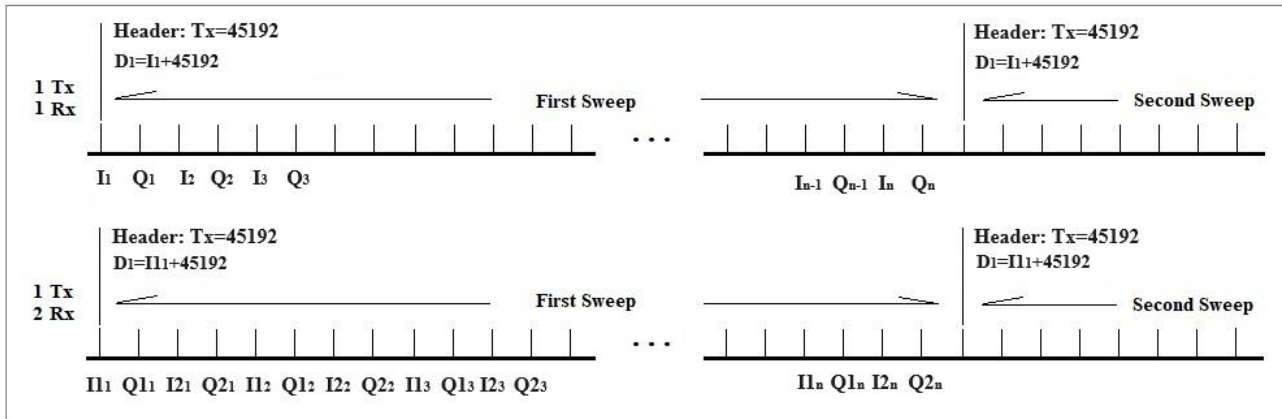

Figure 4. Single Transmitter data stream sequences

A header of 45192 is always added to the first sample  $I_1$  of each sweep. So when the value of one sample is greater than 45192, it means the first sample of a sweep is found. Subtracting 45192 from the first sample value, the value of  $I_1$  remains, and following samples are belong to this sweep until next header is found.

## 3 System Setup

### 3.1 Panels

The front and back panels of PUP\_EN24C\_T1R2 are shown in Figure 5. The connectors on front panel are SMA females. The device use 5.5x2.1mm power jack for 6V DC input power and mini USB connector for data transfer.



Figure 5. PUP\_EN24C\_T1R2

Luswave Technology LLC

Sales: +1-703-338-8380 Technical: +1-571-296-6435 Fax: +1-571-223-5483 Email: service@luswave.com

### 3.2 USB Driver Setup

Find the Driver folder in the include USB flash drive (Figure 6), and copy it to your computer.

DOCs	11/9/2024 2:40 PM	File folder
<b>Driver</b>	11/9/2024 2:40 PM	File folder
Driver-EarlyVersion	11/9/2024 2:40 PM	File folder
PUPradarGUI	3/13/2024 9:05 AM	File folder

**Figure 6. USB Driver**

**First** plug the 6V power into the power jack, slide the power switch to on position, and **then** connect your computer and the device with USB A to USB mini cable.

Open the Device Manager window on your computer, “Unknown Device” is shown (Figure 7) when the device is first connected.

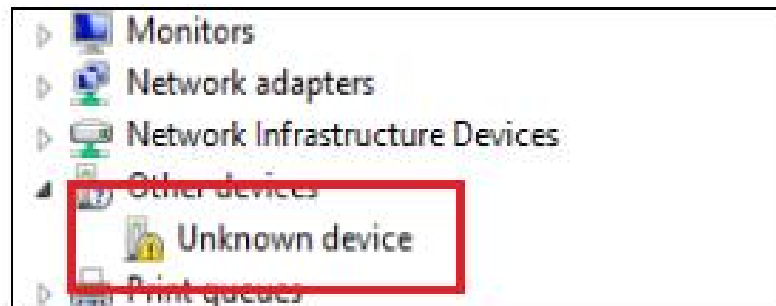

**Figure 7. Device Manager Window.**

When you install the driver for this device using the file in the Driver folder and it shows “**Cypress FX2LP No EEPROM Device**” (platform bought before Feb. 2025), or “**Cypress FX2LP Development board**” (platform bought after Feb. 2025), the driver is installed successfully.



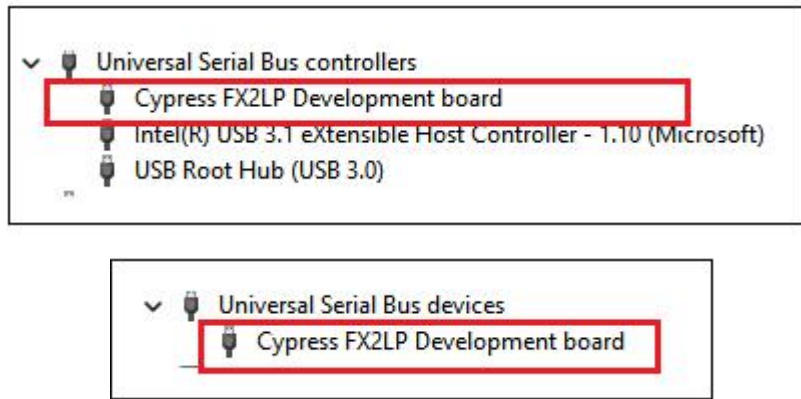

**Figure8. Driver Software Installed Successfully**

In case the USB driver can not be installed, try the earlier versions in the folder “ Driver-EarlyVersion”. Try drivers in win7.

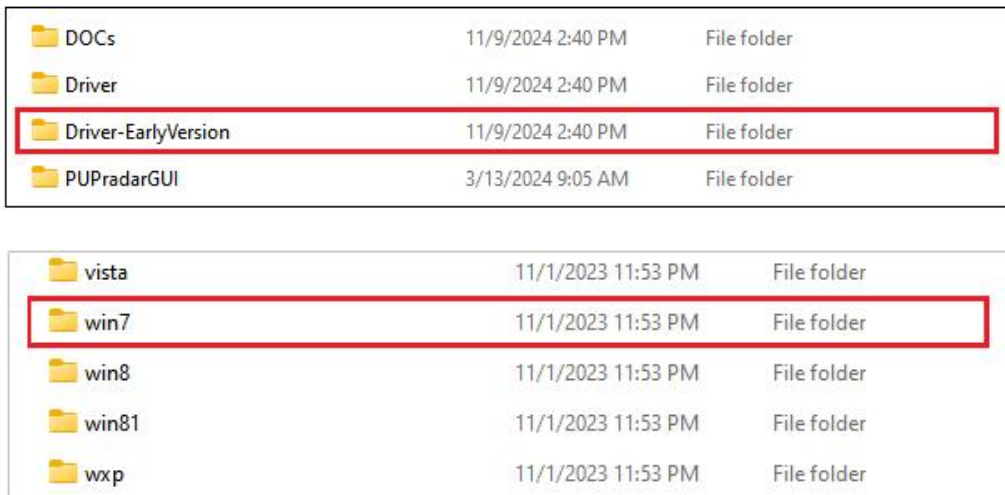

**Figure 9. USB Driver Early Version**

### 3.3 PUPradarGUI Setup

#### 3.3.1 GUI app install

In the USB flash drive, you can find the folder “PUPradarGUI” .

DOCs	11/9/2024 2:40 PM	File folder
Driver	11/9/2024 2:40 PM	File folder
Driver-EarlyVersion	11/9/2024 2:40 PM	File folder
PUPradarGUI	3/13/2024 9:05 AM	File folder

**Figure 10. included documents folders**

Copy the folder “PUPradarGUI” into your Matlab workspace, set the path to this folder, and run PUPradarGUI.m.

### 3.3.2 PUPradarGUI user’s guide

When running the “PUPradarGUI.m”, the GUI window (Figure 11) will appear. By hitting the “Refresh” button, the software will automatically detect the device. When the device is successfully recognized, model name will show in the message window. Now you can hit the “start” toggle button to run the software. The GUI gives users access to configure modulation frequency and other parameters. Anytime you want to record the raw data, select the record time, and then hit the “record” button to start.

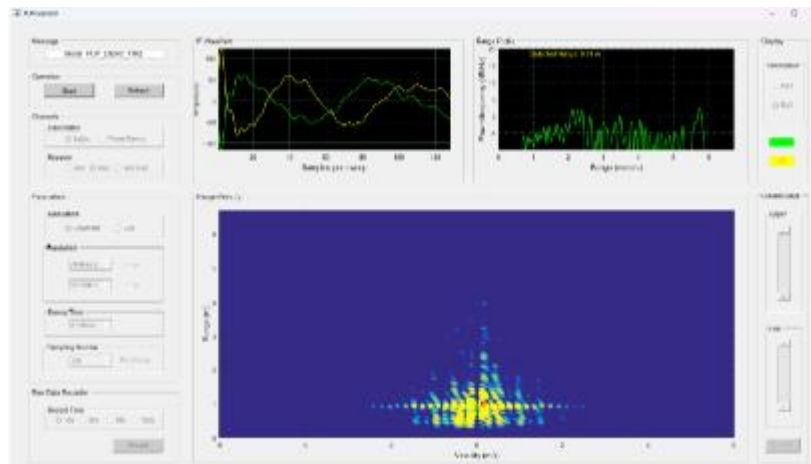

**Figure 11. PUPradarGUI**

- **Message Window**

When the device is detected, the message window will show the model name, otherwise, it will show an error message or ask you to refresh.

- **Operation Panel**

There are two buttons in the operation panel. The start/stop button is a toggle button. The refresh button resets the software to its default status.

- **Channel Panel**

In the channel panel, you can turn on transmitting channel or set as power saving mode. In power saving mode, Only a little bit of power is consumed by the transmitter.

For Rx channels, there are three selections, “Rx1”, “Rx2”, and “Rx1.Rx2”. When “Rx1.Rx2” is selected, the Rx1 and Rx2 data will be transferred to host PC at same time.

- **Parameter Panel**

In the parameter panel, modulations, lower and upper frequencies, sweep time, and sampling number per sweep can be configured.

- **Raw Data Recorder**

When the GUI is running, the buttons in the Raw Data Recorder panel are active. You can start recording at any time. Push record button to start the recording and a save file window will appear after the recording time is over. The default file format is \*.mat, but you can save the file in \*.txt format. More details can be found in “DataRecordingManual.pdf”.

- **Display Panel**

When one Rx channel is activated, the three display windows are for that channel. When both Rx channels are activated, one channel in this panel should be selected for display.

- **Dynamic Range Panel**

The two sliders in the Dynamic Range Panel control the signal threshold in the lower display window. When the slider is lower, it shows more target details. When the slider is higher, less noise is shown from the image.